

Ordering Information pg. 9

MTJ-662BX1-FS

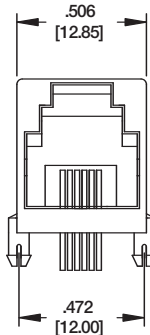

6 POS  
2B SHIELDED

MTJ-882BX1-FS

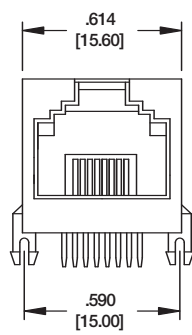

8 POS  
2B SHIELDED

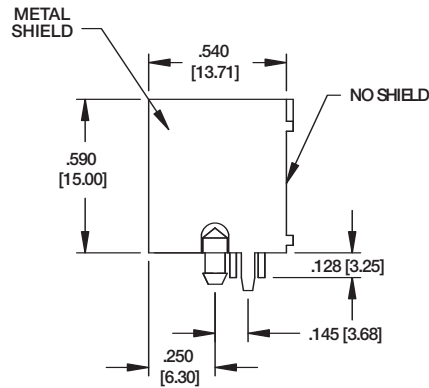

**TYPE 2B  
SHIELDED**  
6P6C  
6P4C  
8P8C



MTJ-662BX1-FS



MTJ-882BX1-FS

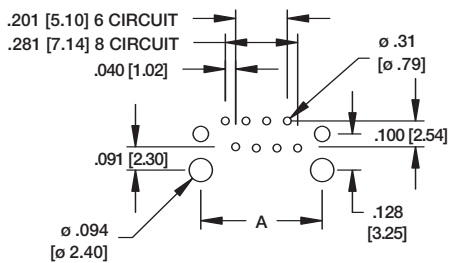

Recommended PCB Layout

DIM. "A"	
TYPE2B 6P6C	.472 [12.00]
TYPE2B 8P8C	.590 [15.00]

**TYPE Q  
COMPACT JACK  
4P4C**

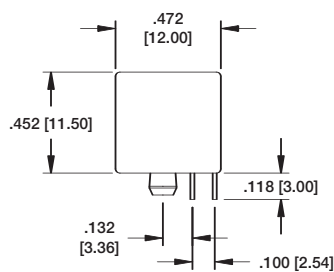
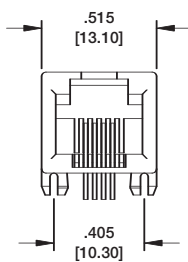

MTJ-44QX1

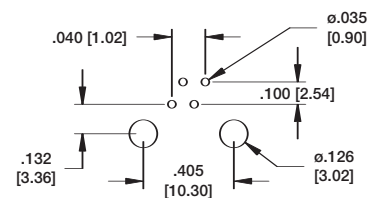
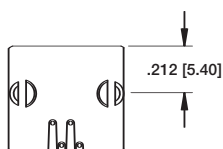

Recommended PCB Layout